

The logo for OLLI, featuring the word "OLLI" in a bold, red, italicized sans-serif font. The letter "O" is stylized with a white lightning bolt shape cutting through it. The logo is set against a white rectangular background in the top right corner of the page.

**OLLI**

The title "FENCING GUIDE 2022" is written in large, white, bold, sans-serif capital letters across the bottom of the page. The text is overlaid on a background of a lush green field with several black cows. Small white silhouettes of a cow, a horse, and a dog are placed around the text: a cow silhouette above the 'F', a horse silhouette above the 'G', and a dog silhouette above the '2' in "2022".

**FENCING  
GUIDE 2022**





# CONTENTS

1. This is how an electric fence works .....	3
2. Electric fence energisers .....	4
3. Earthing .....	6
4. Fence conductors .....	8
5. Insulators .....	10
6. Connectors .....	12
7. Gates .....	14
8. Pastures .....	16
9. Selection tables & problem solving .....	18





# 1

# THIS IS HOW AN ELECTRIC FENCE WORKS

## WHAT IS REQUIRED FOR A SHOCK?

When an animal touches the electrified fence, electricity passes from the fence through the animal into the ground, through the ground to the earthing rods, and through the earthing rods back to the energiser, giving the animal a shock on the way. In this way, a circuit is formed.

**Therefore, there will be no shock when the animal touches the electrified fence, but only when the electricity flows back to the energiser.**

If the electrical path between the animal and the ground is interrupted for some reason, the animal will not receive a shock, even if the energiser functions in the manner intended.

## DROUGHT, SNOW AND ICE IMPAIR CONDUCTIVITY

In good fencing conditions, earth is suitably moist and conducts electricity well. However, the flow of electricity between the animal and the earth can also be interrupted in very dry conditions or on rocky terrain, or if a section of the fence is, for example, covered with asphalt or concrete.

Snow, ice and frozen soil are also efficient insulators. In winter, electricity cannot pass from the animal's feet into the ground through the snow and ice as easily as when the ground is not frozen.

Thus, even if the energiser functions flawlessly, under the circumstances described above, an animal touching the fence does not receive a shock comparable to that under optimal fencing conditions.



A fence assembled in accordance with the winter fencing instructions is a functional solution not only for winter, but also for dry or rocky conditions. Since the normal return of electricity to the energiser through the ground is impeded in such situations, a separate return path for electricity to the energiser must be provided in the form of, for example, two-wire fence or winter fence tape. For the instructions, read the Olli Winter Fencing Guide.

*Are you aware that an electric fence does not need to be a loop? You can electrify a straight fence or a fence of any shape.*

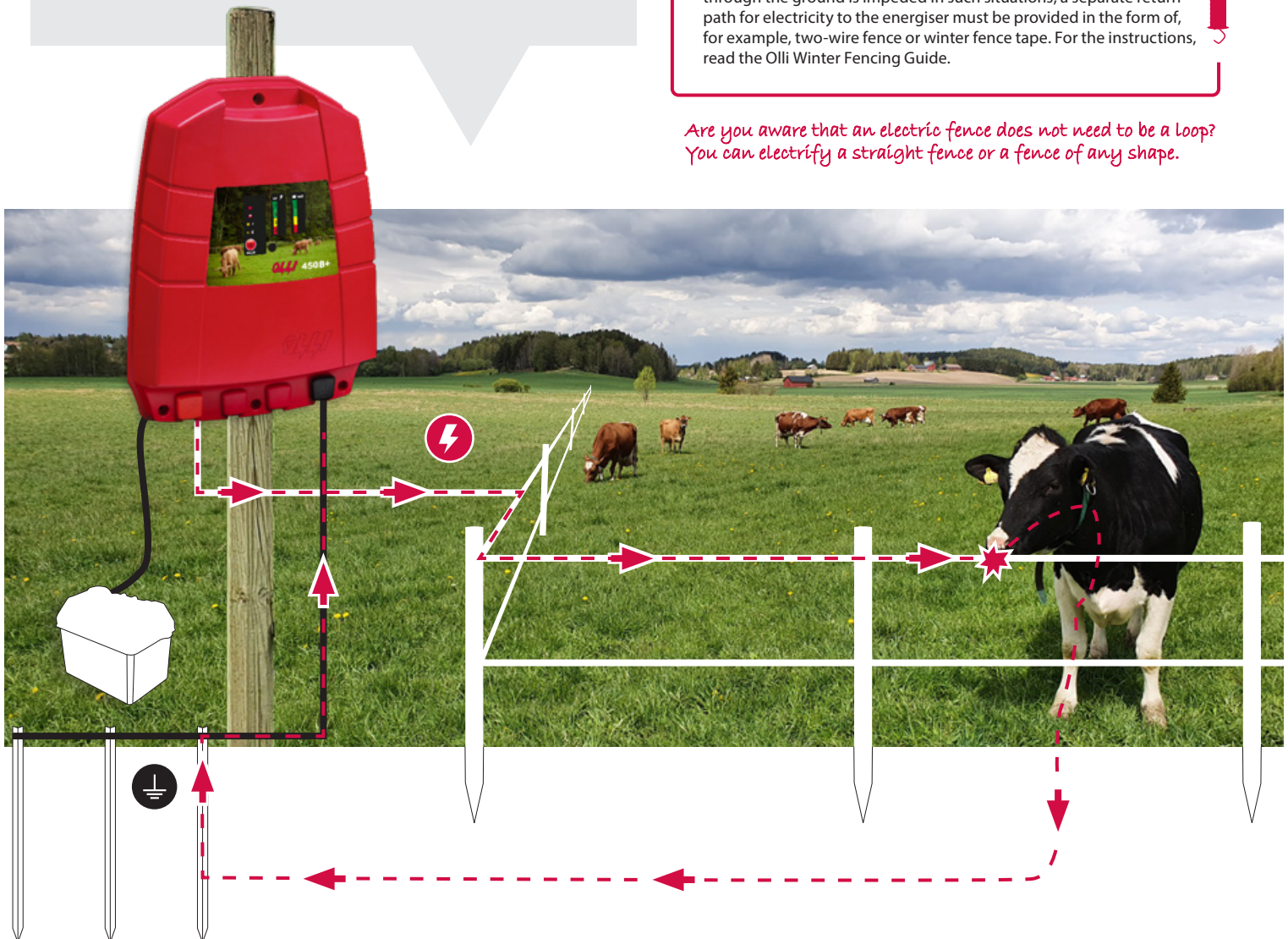



# 2

# ELECTRIC FENCE ENERGISERS

## HOW TO CHOOSE A FENCE ENERGISER

Many things affect the choice of a fence energiser. It is not always necessary to choose the most powerful energiser.

An energiser is expedient if it is appropriate for the particular use for which it was intended.

*A fence is always just as strong as its weakest link.*

A fence should always be thought of as a whole. The fence energiser is only a part of this whole. You should keep in mind that even the best energiser cannot save the whole if the fence itself is substandard – or vice versa.

The functionality of the fence always depends on all the factors, such as the length of the fence, the fence conductors (i.e., wires, ropes or tapes) used, insulators and connections, vegetation contacting the fence, and functionality of the earthing.

**When the whole works, the fence works.**

### TO BE CONSIDERED WHEN CHOOSING A FENCE ENERGISER:

1. Power supply available
2. Fence size
3. Materials used in the fence
4. Animals fenced
5. Fence and fencing conditions

#### 1. Power supply

A **mains energiser** is an option if mains power is available and there is no need for moving the energiser. If you need a heftier shock, you will find the most powerful Olli energisers from our range of mains energisers.

A **battery energiser** is the right choice if mains power is not available or the energiser needs to be moved, for example, between orchards, fences, or pasture parcels. Some battery energisers may also be operated on mains power using an adapter.

A **solar panel energiser** is an easy-care solution in case of fences located far from your farm. The solar panel reduces the need to charge the battery, as the panel takes care of the charging.

#### 2. Fence size

The fence always burdens the energiser. The longer is the fence, the greater the quantity of fence conductor strands and the thicker vegetation leaning on the fence, the higher is the load. For this reason alone, a sily fence needs a more powerful energiser than a small fence. If the energiser is too weak in relation to the size of the fence, the energiser cannot maintain sufficient tension along the entire length of the fence.

The energiser's product information indicates the maximum theoretical length of the fence for which the energiser is suitable. When calculating the length of a fence, remember to add up all fence conductor strands.

#### 3. Materials used in the fence

The fence conductor – in other words, the fence wire, rope, or tape – plays a role of decisive impor-

tance in terms of fence functionality. The purpose of the fence conductor is to convey electric current in the fence as good as possible.

If fence conductors with low resistance are used in a fence, electricity flows well in the fence. Even the most powerful energiser will not be able to maintain sufficiently high voltage in every corner of the fence if the fence conductor excessively interferes with the flow of the current. Therefore, in a long fence, in addition to a powerful energiser, fence conductors conducting electric current well (i.e., of low resistance) are always required.

#### 4. Animals fenced

The animals to be fenced impose certain restrictions on the energiser to be acquired. The energiser must not be too powerful for the animals fenced, but a low-power energiser will also not serve its purpose, allowing the animals to escape.

In addition to the size of the animals fenced, their individual differences should be considered. Some have more respect for the fence, while others need a snappier shock to stay on the right side of the fence. Thick coat and blankets may also increase the need for a more powerful shock.

#### 5. Fence condition and fencing conditions

A fence in poor condition impairs the flow of electricity. Over the years, dirt, moss and other vegetation accumulate on fence conductors and metal strands breaking over time impair the flow of electricity in the fence. Poor or inadequately made connections and extensions add to the problem, as do broken insulators and vegetation contacting the fence.

Inadequate or incorrect earthing is the most common cause of poor fence efficiency. In good fencing conditions, the soil is moist enough and conducts electricity well, as opposed to dry or rocky soil or asphalt or concrete pavement, for example.

To achieve optimal fence functionality even in these challenging conditions, a separate return path for electricity to the energiser must be arranged. In such cases, a fence built in compliance with the winter fencing instructions is a functional solution.



### FIND OUT MORE ABOUT OLLI ENERGISERS

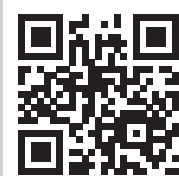

### COMPREHENSIVE WARRANTY, MAINTENANCE, AND SPARE PARTS STOCK

All Olli energisers come with a 3-year warranty that also covers damages caused by lightning. We guarantee availability of spare parts for many years to come, for discontinued models as well.

In service and maintenance-related matters, please contact your local Olli Dealer in your region.

#### Contact us!

Farmcomp Oy, Jusslansuora 8, 03460 Tuusula, Finland | info@farmcomp.fi | +359 (0)9 7744 970  
Mon–Fri 9 AM–3PM | www.ollifinland.com

**TIP!** It is a good idea to have a spare energiser in case the fence energiser in use malfunctions, for example, as a result of a lightning strike. If you use a mains energiser, a battery energiser intended for summer pastures, for example, makes a good spare energiser – you can use it to electrify the fence even during longer power outages. An old, decommissioned energiser can be kept as a spare energiser, and even defective units can in most cases be repaired. It is always a good idea to request a maintenance and cost estimate for reconditioning of an old Olli energiser.

Read the full article [on battery selection on Olli's blog](#)



### CHOOSING THE RIGHT BATTERY FOR THE JOB SIGNIFICANTLY PROLONGS ITS SERVICE LIFE

Choosing a battery for an energiser seems a difficult task: there are so many options... A few related tips can save you the trouble of constant rummaging through stores.

#### Battery tips in a nutshell:

1. In energiser use, prefer leisure batteries to starter batteries.
2. Charge batteries as soon as they become half-full.
3. Remember to charge a battery regularly even when not in use.
4. In winter, do not store batteries in unheated premises.

## VOLTAGE

There is no constant, uninterrupted electric current in the fence; the energiser outputs electric impulses to the fence at just over a second. For safety reasons, the impulse is very short, typically under a thousandth of a second. Fence voltage refers to the highest instantaneous impulse voltage that can be measured with a fence voltage tester. The unit used is volt (V).

In a short fence in good condition, the voltage can reach 10,000 volts, for example. By comparison, in case of an AA-size battery, the respective number is 1.5 volts. You can safely touch an AA battery with bare hands without electric shock, as the voltage is so low that no electric current passes through the skin.

The voltage generated by a fence energiser is clearly higher, since the objective is to make sure that when an animal touches the fence, electric current will flow even if the animal is thick-haired and thick-skinned and most of the voltage is lost on the way to the fence conductors. Therefore, sufficient voltage allows the current of the fence energiser's impulse to pass through the animal, giving it a shock.

## ENERGY

A fence energiser is supplied from the mains, battery, or solar panel, and accumulates energy before discharging it into the fence in impulses at just over a second.

In the technical data of fence energisers, the maximum output energy is usually indicated. The unit used is joule (J). Maximum output energy indicates the shock intensity, in other words, the maximum energy the fence energiser is capable of supplying to the fence in a single impulse. The more energy there is, the longer fence can a fence energiser supply with sufficiently high voltage. The higher the energy, the longer and more perceptible the shock.

On the other hand, higher energy means higher power consumption, which in battery-powered devices entails the need for more frequent charging.

However, keep in mind that even the most powerful energiser will not be able to raise the voltage high enough if the fence conductor excessively interferes with the flow of the current. Therefore, in a long fence, fence conductors conducting electric current well (i.e., of low resistivity) are always required.

Most powerful mains energiser

## MAINS ENERGISERS

Olli Protector 11



11 J

Olli Protector 11 is the most powerful Olli energiser of all time! Powerful 11J output energy keeps even the stubbornest animals on the right side of the fence. Highly powerful, modern intelligent energiser.

Olli 1000



4,5 J

A powerful energiser, 4.5J output energy. Comprehensive, backlit graphic display for continuous monitoring of the fence condition. The output energy is automatically adjusted to the load.

Olli 950



4,8 J

A powerful basic energiser for more demanding use. Snappy 4.8J output energy. InfoLED for reduced fence voltage warning. Good price/quality ratio!

Olli 600



3,8 J

A reliable basic energiser, medium-level 3.8J output energy. A reliable mains energiser also for varying fencing conditions.

Olli 300



2,8 J

A basic mains energiser, medium power level, output energy 2.8J. Best suitable for slightly shorter fences.

Olli 100



1,2 J

Olli's least powerful mains energiser, suitable for short fences under easy fencing conditions. Output energy 1.2J.

Solar panel available as an accessory

Most powerful battery energiser

## BATTERY AND SOLAR PANEL ENERGISERS

Olli 450B+



3,0 J

Olli's most powerful 12V battery energiser, 3.0J output energy. Versatile energiser, 4 different operating modes, LED-display. Solar panel available as an accessory. Wall or post-mounted model.

Olli 250B+



2,0 J

Versatile 12V battery energiser, 2.0J output energy. 4 different operating modes, LED-display. Solar panel available as an accessory. Wall or post-mounted model.

Olli 180B



1,4 J

A basic battery energiser, 1.4J output energy. Wall or post-mounted model, 12V rechargeable battery operated. Low power consumption.

Olli 122B



1,21 J

Olli's most versatile battery energiser, which can be used with mains power, solar panel, or batteries. Automatic power source selection. 1.21 J output energy. Supplied with a mains adapter and earthing spike.

Olli 9.07S

Olli 9.07B



0,71 J

9.07B is a 9V battery energiser that can also be connected to a 12V battery. Supplied with a mains adapter and earthing spike. Solar panel available as an accessory. The 9.07S is additionally provided with a 12V battery and 6W solar panel.

Olli SG3



0,3/0,125 J

The smallest and lowest-powered model in the Olli family for fencing small animals and areas. Output energy: 0.3J with rechargeable battery, 0.125J with batteries.





# 3

# EARTHING

*There cannot be too many earthing rods. Better some extra than too few.*

## THE SIGNIFICANCE OF EARTHING

Inadequate or incorrect earthing is the most common cause of poor fence efficiency. By compliant and functional installation of the earthing in accordance with the instructions, you can often eliminate many problems related to poor fence efficiency.

An animal touching the electrified fence receives a shock when the electricity passes from the fence through the animal into the ground, through the ground to the earthing rods, and through the earthing rods back to the energiser. If electricity cannot return to the energiser, there will be no shock.

**Therefore, earthing rods are tasked with providing a return path for the electricity from the soil to the energiser. The more reliable is this path, the more likely is the fence to deliver a shock.**

Adding earthing rods and improving earthing conditions will make it easier for electricity to reach the energiser and may greatly improve the functionality of the fence.

## COMMON CAUSES FOR INADEQUATE EARTHING

1. Incorrect placement of earthing rods; for example, in dry macadam under the eaves of a building.
2. Dry, rocky or stony soil or soil areas adjacent to the fence are paved in asphalt, or of concrete, rock or other poorly conductive material.
3. Earthing rods not buried deep enough.
4. Incorrect earthing rod material (for example, one subject to corrosion).
5. Poor connections along the cable connecting the earthing rods to the energiser.
6. Insufficient quantity of earthing rods in relation to the energiser power and fence size.



**DID YOU KNOW?** If there is no suitably moist area for earthing near the energiser, the earthing rods can also be placed away from the energiser. In addition, earthing rods may be located in several places. We recommend using Olli High Voltage Cable for connecting remote earthing fields to the energiser.

**1** Dry earth is a poor conductor. Dry areas located under the eaves and covered in macadam are a good solution for the building, but a poor choice in terms of electrical conductivity. In addition, the earthing rods should be placed to the distance of at least 10 metres from residential and farm buildings, as generally other earthed systems, such as sections of electricity networks or water mains are found in such buildings

**2** Besides dry land, rock, asphalt, and concrete conduct electricity poorly. Wetting the dry land temporarily improves the contact between the earthing rods and the ground, but for permanently dry conditions, we recommend building the fence in accordance with the winter fencing instructions, with a separate return path for electricity to the energiser, in the two-wire fence configuration or using winter fence tape.

If there is no suitably moist area for earthing near the energiser, the earthing rods can also be placed away from the energiser. In addition, earthing rods may be located in several places. We recommend using Olli High Voltage Cable designed for energiser use for connecting remote earthing fields to the energiser.

**3** If an earthing rod is not buried completely under the soil, some of its capacity will remain unused. In general, the deeper you dig, the moister the soil, and for this reason as well the earthing rods should be covered in ground over their entire length. Last but not least, there is the risk of stumbling over earthing rods sticking out of the ground and getting injured.

**4** Rebars or other corroding materials constitute a poor choice for earthing rods, as rust insulates and prevents the flow of electricity.

**5** Poor connections can prevent the return of electricity from the earthing to the energiser. In such cases, there will be no shock. Use screw connections to ensure sufficient contact.

**6** The more powerful the energiser and the longer the fence, the greater can be the energy passing through the fence and earthing. In case of fence conductors or earthing incapable of conducting higher currents, a more powerful energiser cannot be used to its full benefit. Electrical conductivity of the earthing can be improved by enlarging the size of the earthing field – in other words, by increasing the number and/or quality of earthing rods.

# EARTHING ROD INSTALLATION

Adequate earthing of the fence energiser requires a sufficient number of earthing rods. Depending on the length of the fence and the power of the energiser, 1–6 earthing rods are usually needed. In dry conditions and in case of long fences, even more earthing rods may be required. There cannot be too many earthing rods; better have some extra than too few.

Bury the earthing rods completely under ground, at a distance of at least 1m from each other. No earthing rod may remain visible; all of them must be completely buried under the ground.

The best place for an earthing rod is moist soil or loam – for example, a ditch bank. If the soil is quite dry, regular watering of the earthing location improves earthing contact with the ground. For permanently dry conditions, we recommend building the fence in accordance with the winter fencing instructions, with a separate return path for electricity to the energiser, in the two-wire configuration or using winter fence tape.

The current in the electric fence flows from the

energiser to the fence conductors, passes into the soil through the animal touching the fence, runs through the soil to the earthing rods and from there through earthing wire back to the energiser.

To prevent interference caused by the current flowing in the ground, the earthing rods should be placed so that there are no structures between the fence and the earthing rods. If necessary, the earthing rods can be installed at a distance from the energiser using a high voltage cable.

The earthing rods must be placed to the distance of at least 10 metres from other earthed systems, such as electricity networks or water mains. As these are commonly found in residential buildings and farm facilities, the safety distance should be measured away from the building's plinth, avoiding wells and power supply and telecommunications system lines.

An especially bad idea is to connect fence earthing by a wire to the protective earth of the electricity system, as it causes interferences in electrical and telecommunications equipment.

A lightning conductor intended for protection of other systems is also not to be applied for energiser earthing purposes.

The diameter of the earthing wire must be at least 1mm and it must always be connected to the earthing rods by screw joints to ensure adequate contact. Olli earthing rods are supplied with a 3m connection wire and mounting screws.

Note that if you equip your fence with a separate lightning protector for the fence energiser, it requires its own earthing rods (at least 3 pcs.) in addition to the earthing rods of the energiser.



## Olli Earthing Rod

- Hot-dip galvanized earthing rod for fence energisers
- Length 1m
- L profile sharpened at the end
- Includes 3m connection wire with mounting screws.



The **lightning protector** protects your energiser against lightning strikes conveyed by the fence by diverting the lightning into the ground before it reaches the energiser. To be installed between the fence and the energiser. Hot-dip galvanized.

## LIGHTNING PROTECTOR EARTHING

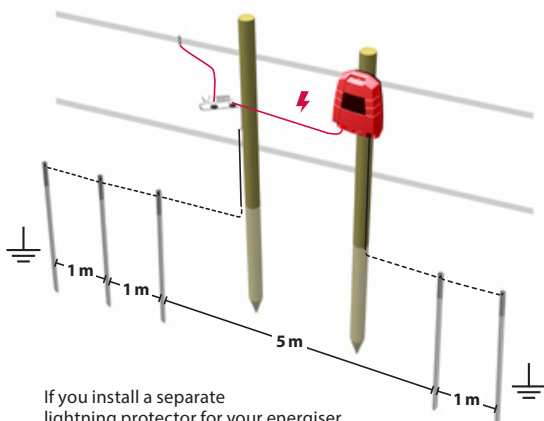

If you install a separate lightning protector for your energiser, keep in mind that it requires its own earthing rods.

There must be at least three lightning protector earthing rods, which must be installed at a distance of at least 1m from each other and at least 5m from the energiser's earthing rod.

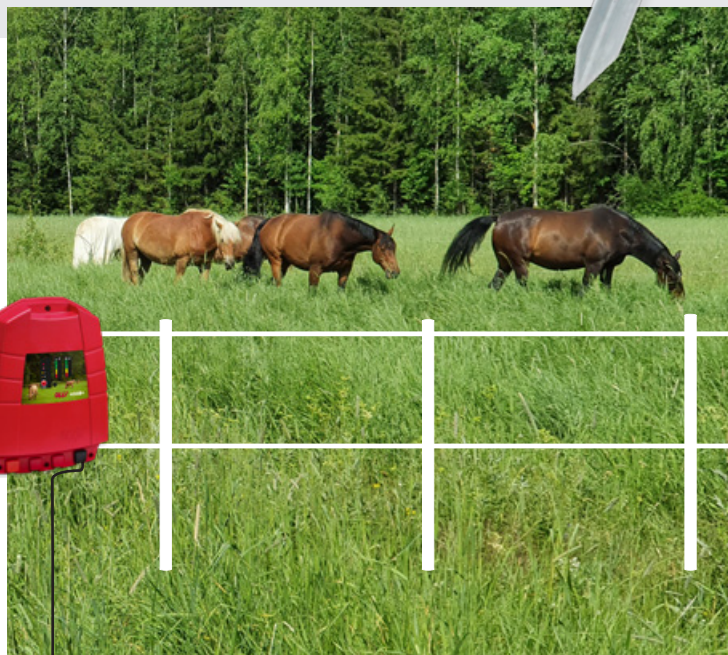

Earthing rods should be completely buried under the ground. In this case, the entire length of the rod is put to use.

The animals can also stumble over earthing rods not buried deep enough or exposed wires and injure their feet.

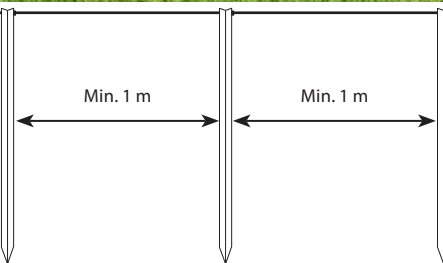

## THE FENCE IS STILL NOT WORKING?

Now that earthing is in order, there are still problems with the fence?

For detailed instructions on how to determine the condition of the fence, see the Olli blog. ▶





# 4

# FENCE CONDUCTORS

## THE TASK OF FENCE CONDUCTORS

The task of the fence conductor, in other words, fence wire, rope or tape, is to conduct electric current in the fence and to pass it to animals touching the fence. The lower is the resistance ( $\Omega/m$ ) of the fence conductor, the smaller is its resistance to the flow of electricity, i.e., the better it conducts electricity. To ensure maximum efficiency of the energiser, the fence conductor should conduct electricity as good as possible.

A fence is always a whole, all parts of which affect each other. The list of factors influencing the choice of the fence conductor is very similar to that considered when choosing the fence energiser. Even though good electrical conductivity is the most important feature of a fence conductor, it is not the sole basis for choosing the fence conductor.

### TO BE CONSIDERED WHEN ACQUIRING FENCE CONDUCTORS:

- Is the fence to be built intended for long-term/year-round or only temporary use?
- What is the size of the fence to be built?
- How much fence maintenance and repair works are you prepared to carry out in the future?
- What are the prevailing conditions in the fence area?
- For what kind of animals is the fence intended?

### FENCE SIZE/USE

The choice of the fence conductor is significantly affected by the size and the service life of the fence (for example, temporary summer pasture/permanent year-round fence): The larger the fence, the more important are good electrical conductivity (i.e., low resistance) and reliable quality of the fence conductors.

The choice of high-quality, highly electrical-conductive fence conductors withstanding seasonal changes not only promotes the flow of electricity, but also reduces the need for future maintenance and repair of the fence.

### FENCING CONDITIONS

Is the fence to be located in an area where there is typically snow and ice in winter? Is the soil rocky or very dry in summer? In all such cases, we recommend building a year-round fence in accordance with the winter fencing instructions, with a separate return path for electricity to the energiser – for example, in the two-wire configuration or using winter fence tape. This way, functionality of the electric fence can be ensured regardless of the season.

The fencing conditions also affect the width of the fence conductor chosen. Wide fence tapes can be used to assemble a fence more visible as compared to one consisting of thin wires; such a fence will clearly stand out from the background. However, snow, ice and wind should be considered when choosing fence conductors: The wider the fence conductor, the more susceptible it is to snow, ice, and wind load stretching the fence tapes. Wide fence tapes may need cleaning from insulating snow more often as compared to thin wires.

Also, consider vegetation: Grass or branches contacting the fence always cause extra load for the energiser, lowering the voltage. If escape from under the fence is not an option, the lowermost fence conductor can be placed at a height where the undergrowth cannot reach it. In other cases, regular mowing of the vegetation must be ensured.

**Tip!** It is a good idea to install the lowermost fence conductor so that it can be de-energised easily if in contact with vegetation or snowdrift.

### ANIMALS FENCED

The height of the fence and the number of fence conductor strands depend on the animals fenced. The larger the animals, the higher the fence required. The fence height is right if the animals cannot escape over, under, or through it.

The respect the target animals have for the fence should also be considered – for some, a thin fence conductor strand is sufficient, while others require a fence with several strands of fence tape visible from far away.

A fence can well be assembled using different fence conductors in different strands of the fence. This way, the best qualities of different fence conductors can be utilised: For example, use wide fence tape for improved fence visibility, metal wire for top-notch electrical conductivity, and thinner (and often less expensive) fence wire for reduced snow and wind load.

However, always pay attention to species-specific behavior of the animals fenced: In case of horses, for example, tightly tensioned steel wire fences are not recommended due to the risk of injury.

*Polyethylene (PE) highly resistant to UV radiation is used in high-quality fence conductors.*



**SHOCKTEQ™**

*In the Olli fence conductor family, Shockteq products are particularly durable and therefore ideal for year-round, permanent fences. The products can be identified by the product label.*



# FENCE CONDUCTOR QUALITY IS PARAMOUNT



In order to understand the importance of the role of fence conductors, you should pay a closer look on how electricity flows in the fence.

The fence energiser generates a fence impulse about once a second. In case of a high-power energiser, the pulse is longer than that of a low-power one, but for reasons of safety, the pulse is always very short, typically lasting less than a thousandth of a second. In this short time, electricity must make it even to the farthest corner of the fence.

Electricity travels at approximately the speed of light, so this does not pose a problem, but the conductivity of fence conductors, the number of conductor strands, and the length of the fence greatly affect the heights that the voltage level reaches during the impulse at different points of the fence.

In addition, vegetation contacting fence conductors and defective or moist insulators leak current from the fence conductor to the earthing.

The purpose of the fence conductor is to conduct electricity in the fence. Even if there are no vegetation-related leaks, fencing always induces a load for the energiser. The longer is the fence and the greater the quantity of fence wire strands, the higher the load. For this reason alone, a long fence requires a more powerful energiser. However, a more powerful energiser is of no use at all if the fence conductor does not fulfil its function, i.e., conduct electricity well enough. As the voltage increases, a more powerful energiser may even add to problems if the fence itself is not in order.

Therefore, fence conductors with low resistivity should be used in a long fence. Otherwise, the conductor will slow down the voltage rise at the farthest point of the fence to such extent that the voltage fails to reach a sufficiently high level during the short pulse. Replacing your energiser with a more powerful unit will extend the pulse and can thus help a little, but in most cases not even closely enough.

**For a better idea, imagine that a high-performance energiser is a water bucket from which water is splashed to a drain (i.e., fence wire) at every impulse.**

**If the drain is a municipal grade water main pipe (that is, a steel fence wire, for example), all of the water splashed will happily flow away.**

**However, if the drain is a drinking straw (the cheapest fence wire purchased from a discount store), the water splashed is mostly spilled and only the amount passing through the straw reaches the fence. When dripping water from a drinking glass (that is, a smaller energiser), the straw will do its job – that is, if the fence is short.**

## CONDUCTIVE PARTS OF FENCE CONDUCTORS

Steel fence wires are fully made of conductive material, whereas fence ropes and tapes are not. They consist of plastic and thin metal strands or conductors in which the electricity flows. Besides improving visibility, the plastic in fence tape facilitates handling.

The electrical conductivity of a fence conductor depends on the metal used in the electrically conductive components, their diameter and quantity. The thicker the metal strand, the better electricity flows through it.

Conductor strands made of different metals are used in fence wires, ropes and tapes. The options commonly employed include stainless steel (inox/RST), aluminium (Al), and copper (Cu). Each of the metals has its advantages: For example, the very widely used steel is both a durable and affordable material. Electrical conductivity can be improved by supplementing steel strands with aluminium or copper strands. For example, the electrical conductivity of copper exceeds that of steel 40-fold. However, as materials, copper and aluminium are more expensive and not as durable as steel.

When looking for a fence conductor with optimal electrical conductivity, it needs not contain these more expensive metals: Lower electrical conductivity of materials can be compensated by increasing the metal conductor thickness.

When comparing the properties of fence conductors, do not be fooled by the sheer number of metal conductors; quantity does not replace quality. In 0.4mm strands, the flow of electricity is considerably smoother as compared to 0.2mm ones, even if the narrower conductors come in greater numbers. The low price of least expensive fence tapes has been achieved through compromises on account of the metal conductors (their thickness, quantity, and material).

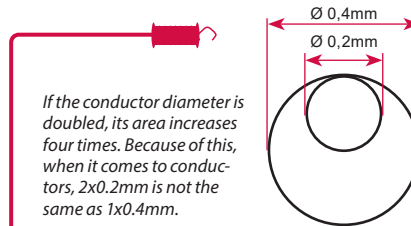

## EVEN FENCE CONDUCTORS NEED CARE

Fence conductors not only of poor quality, but also of poor condition impair fence functionality. Even though high-quality fence wires, ropes and tapes intended for year-round use last long, they do not last forever: A time when they must be replaced will inevitably come.

Over the years, dirt, moss and other vegetation accumulate on the fence conductors and metal conductors (i.e., the very conductors of electricity) breaking over time impair the flow of electricity in the fence. Moreover, if fence extensions and connections have been made carelessly, for example, using knots, in which the metal conductors of the fence conductor are not in proper contact and generate sparks, it is difficult for the electricity to flow smoothly in the fence.

Fence conductors require tensioning as the time passes: Temperature fluctuations, snow and ice accumulating on the conductors, animals colliding with the fence, etc. lead to stretching of the fence conductor. Hanging conductors may contact each other and generate sparks, which will burn the conductor through over time. If metal posts have been used in the fence, a loosely hanging conductor may contact them and cause voltage drop in the entire fence.

**The lower the resistance ( $\Omega/m$ ) of a fence conductor, the better it conducts electricity**





# 5

# INSULATORS

## THE PURPOSE OF INSULATORS

Fence conductors are fixed to fence posts with insulators. In addition to this fixation, as the name suggests, the function of an insulator is to insulate, i.e., to ensure that electricity passing through the fence conductor cannot end up somewhere it does not belong – for example, in a fence post, causing a voltage drop and weaker shock.

*Always choose insulators compatible with the fence conductor used.*

The function of an insulator is to insulate the passage of electricity from a fence conductor to somewhere it does not belong – for example, a fence post. An insulator in poor shape or of poor quality performs this function poorly. Electric current leakages cause voltage drop, leading to weaker shocks.

Besides being mechanically durable and having an adequate insulating layer, an insulator of good quality must be suitable for Finland's demanding weather conditions – for example, it should not brake at low temperatures or become brittle under the sun the very first summer.

## TO BE CONSIDERED WHEN CHOOSING INSULATORS:

1. fence conductor used in the fence
2. fence post material
3. sections requiring special durability, such as corners
4. gates

## HOW TO CHOOSE INSULATORS

When choosing insulators, attention should be paid not only to the good quality of the insulator, but also to its suitability for the fence conductors in use – and fence posts. Some insulators can only be attached to wooden posts.

The fence conductor must fit into the insulator without bending. Fence conductors bent (or extended by knots) cause sparks, making it difficult for electricity to flow through the fence. In addition, the sparking spot may burn through over time. There is a suitable insulator for every fence conductor. Many insulators can also be used with more than one type of fence conductors.

Some fence sections may require different insulators as compared to the rest of the fence. For example, at the corners, the fence conductor is often subjected to tensile forces, so it may be necessary to select a mechanically strong insulator for such locations to prevent self-release.

In addition, special insulators are required for gates. Gate insulators are available for fence wires and ropes, as well as for fence tapes.

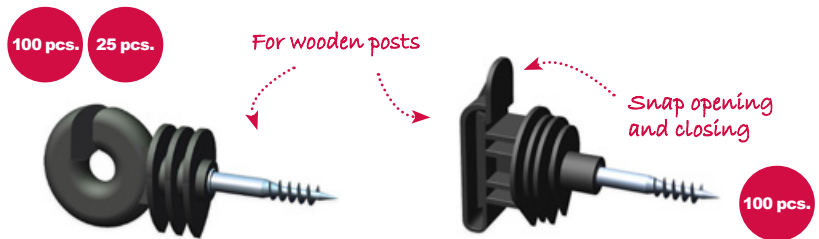

The **Ring Insulator** is a screw-in insulator for all fence wires and max. 8mm fence ropes. Two package sizes, 100 pcs. and 25 pcs.

The **Tape Insulator** is a screw-in insulator for 12–40mm fence tapes. The insulator is provided with quick tape lock. Package size 100 pcs.

The 100 pcs. ring insulator and tape insulator packages include a handy **Mounting Tool** to be fixed on a drill. The tool can also be purchased separately.

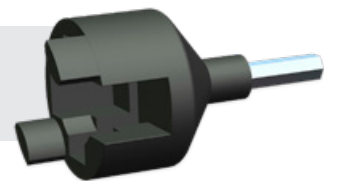

The **Offset Ring Insulator** is a screw-in ring insulator with 19cm long steel stem. Suitable for all fence wires and max. 8mm fence ropes. Two package sizes, 10 pcs. and 100 pcs.

Offset ring insulators keep fenced animals farther away from the fence.



The **Nail-on Insulator** is an affordable insulator for wires and thin tapes. Attachment by nail or screw. Weatherproof, white UV-protected special polypropylene. 100 pcs. per package.





**Tip!** Fence ropes and wires can be conveniently connected to gate handles with **Olli rope and wire connectors**.

**Tip!** Wide fence tapes can be connected more conveniently to the gate handle with **handle hook and tape connectors**.



For wooden posts



2 pcs.

**Gate Insulator** for receiving the gate handle. Suitable for fence wires, ropes and thin fence tapes. The conductive components are made of long-lasting stainless steel. 2 pcs. / package.

**Gate Insulator for fence tapes** for receiving the gate handle when fence tapes are used. Usable also with fence ropes. The fence tape or rope can be conveniently connected to the gate insulator without dedicated connectors. Supremely durable and strong insulator, metal parts of stainless steel. 2 pcs. per package.

**Tip!** Without the metal plate intended for the gate handle, it can also be used for reinforcement of fence corners.



2 pcs.

The package includes all the necessary fastening screws.

Attachment by two screws, recommendation: 4.5x50mm



50 pcs.

8 pcs.

The **Duo Insulator** is a multi-purpose insulator for all Olli fence wires, tapes and ropes of any width. The cover part can be turned into two positions depending on the fence conductor (wire, rope or tape). 50 pcs. and 8 pcs.

**Tip!** Duo insulators are also suitable for extending winter fence tape.

**Tip!** The Duo insulator is characterised by exceptional mechanical strength and is thus applicable, for example, at corners for fence reinforcement, even if some other insulator type is otherwise used.

The tensioner can be fully opened, which means that installation can also be carried out afterwards, on completed fence.

Use Duo insulators to reinforce a fence implemented with Multi insulators at the corners.



25 pcs.

The **Multi Insulator** is a convenient combination insulator for all Olli fence wires, tapes and ropes of any width.

The fence wire, rope or tape is easy to replace without detaching the insulator. 25 pcs. per package.

Attachment by two screws.



2 pcs.

The **Fence Tape Tensioner** keeps fence tapes straight and prevents twisting. It tensions the tape evenly from both directions. Suitable for all Olli fence tape widths and winter fence tape. Fence tape can be tensioned by hand, without tools. 2 pcs. per package, fastening to fence post by two screws.

Depending on the fence size and the number of fence tape strands, you need two or more fence tape tensioners. Place the fence tape tensioners at the middle sections of the fence or at locations where the fence tape starts to hang or twist. Do not overtighten the fence tape to prevent snapping of its plastic and metal strands.

**Spare insulator** for yellow fibreglass posts and spring steel posts. The insulators can be used with fence wires and fence tapes of maximum width 12mm.



25 pcs.



## FOR HIGH TENSILE STEEL WIRE FENCES



4 pcs.

**Porcelain Corner Insulator** for steel wire fences. Diameter 50mm. 4 pcs./package.



10 pcs.

**Especially strong Egg Insulator** for steel wire fences. For corners and fence conductor ends. 10 pcs./package.



55 pcs.

**Rope and Wire Insulator** for steel wire fences. Attachment by two nails or screws. 55 pcs./package.



25 pcs.

**Lockable Insulator** for steel wire and rope. Attachment by two nails or screws. 25 pcs./package.

Also suitable for spring steel posts.



# 6

# CONNECTORS

## THE PURPOSE OF CONNECTORS

Poor connections and extensions prevent smooth flow of electricity in the fence, resulting in voltage drop and weaker shock. Using metal connectors intended for electric fence, connections of fence conductors can be made so that the flow of electricity is not impaired.



*Metal fence connectors conduct electricity well over their entire surface.*

## AVOID KNOTS AND POOR CONNECTIONS

Every poor connection impairs the flow of electricity, and the effect is multiplied if there are many poor connections. Knots are not recommended at fence conductor connections or extensions for reasons related to the flow of electricity.

- The flow of electricity in a knot is impaired, because the metal conductors of the fence conductor do not always coincide inside it and nothing presses the aligned conductors against each other in a reliable manner. An electric fence works best if electricity can flow through it as freely as possible, which means that knots or other obstacles do not contribute to the functionality of the fence.
- When the electrically conductive metal conductors of a fence conductor inside a knot almost touch each other, but are not in proper contact, sparks are generated. Over time, the sparking can burn the metal conductors and the fence conductor all the way through, which is also not beneficial for fence functionality.
- Tensioning of a fence tape whenever required is much more easy and convenient at the connector, instead of, at worst, untying several series of tight closed knots.

*Every poor connection impairs the flow of electricity. If there are many poor connections, the effect is multiplied and the fence voltage can drop significantly. In such a case, the fence cannot deliver a proper shock even if the energiser functions flawlessly.*



*Every poor connection impairs the flow of electricity.*

## CONNECTIONS AND EXTENSIONS

Fence conductor connections and extensions must be made so that interference with the flow of electricity is prevented. In practice, this means that the better the thin metal wires contained in the fence conductor touch each other on both sides of the connection/extension, the better the electricity flows.

The most reliable way for making connections is by using metal fence connectors, since they conduct electricity well – and over their entire surface. In addition, they are easy to open and close, for example, in connection with fence conductor tightening or replacement.



*However, if the fence conductor has to be temporarily tied due to lack of connectors, the flow of electricity can be promoted by stripping the metal conductors over a short distance at the knot and connecting them tightly together.*



## POOR CONNECTIONS IMPAIR THE FLOW OF ELECTRICITY

The better the thin metal conductors contained in the fence wire touch each other on both sides of the connection, the better the electricity flows in the fence. In poor connections, the metal conductors do not contact each other well enough, which reduces the flow of electricity in the fence.

Knots are a typical example of a poor connection where the metal conductors of the fence wire are not in proper contact. In addition, the sparking occurring in knots and other poor connections can burn the metal conductors or even the entire wire through over time, rendering the fence non-functional.



Every poor connection impairs the operation of the fence and the shock it delivers.

If there are many poor connections, the problem is multiplied. Some knots can function quite well – for a while.

With metal fence connectors, you can make functional, highly conductive connections.



7mm sleeve

10 pcs.

**Metal wire connector** for 3mm fence wire, cable, and metal wire. For making joints and splices. Screw tightening. 10 pcs./package.



10mm sleeve

10 pcs.

**Metal rope connector** for 58mm fence rope and elastic gate rope. For making joints and extensions. Screw tightening. 5 pcs./package.

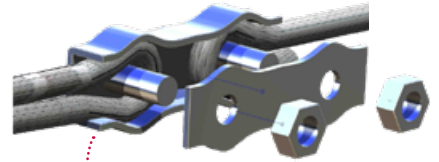

5 pcs.

Tool-free fastening by two wing nuts

**Screw-in tape connector** for connecting, extending and branching 40mm fence tapes. Usable also with narrower fence tapes. Stainless steel. 5 pcs./package.

Connector cable

Accessory set

6 pcs. gate handle



6 pcs. tape connector

**Accessory set** for connecting 10-40mm fence tapes, for connecting gate handles, and for interconnections, i.e., for routing electricity from one fence tape strand to another. Stainless steel connectors.

10-12mm

10 pcs.



**Tape connector** for 10-12 and 20mm fence tapes. Stainless steel. Suitable for joining and extending fence tapes.

20mm

5 pcs.

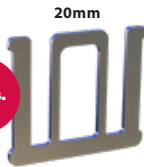

Two widths:  
• for 10-12mm tapes  
• for 20mm tapes  
Use connector equipped with wing nuts for 40mm fence tapes.

Threading a fence tape into tape connector:

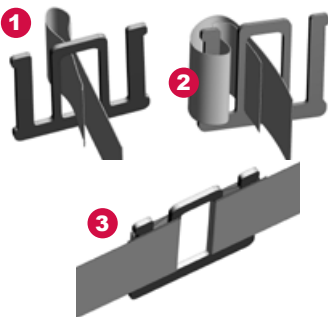

For improved rope fence safety

**Safety connector** for fence ropes. Lightweight and tubular connector made of aluminium, for 5-8mm fence ropes. The rope is fixed by squashing the collar of the tube with pliers. Connect the metal conductors of the fence separately to ensure the flow of electricity. 10 pcs./package.

10 pcs.



**The connection made using the safety connector will come loose upon animal collision with the fence. This reduces both the risk of injury and more extensive damages to the fence.**

## FOR HIGH TENSILE STEEL WIRE FENCES:



**Gripping steel wire joiner.** Two sizes: 1.4-2.2mm and 2.0-3.25mm. 20 pcs./package.

20 pcs.

**Installation tool** for High Tensile steel wire and connector installation. Allows tensioning of steel fence wires to the desired level.

For interconnections

**Wire connector for steel wires.** Galvanized. Intended for interconnections, does not withstand high tensile force. 10 pcs./package

10 pcs.



**Accessory set for winter fence tape.** Accessories for making winter fence tape joints and extensions:  
3m fence connector wire  
2 pcs. connector cable for winter fence tape  
2 pcs. gate handle  
2 pcs. tape connector  
2 pcs. Duo insulator  
4 pcs. wood screws for Duo insulator attachment



Accessory set



**Connector cable for winter fence tape.** The connector cable reliably interconnects the tape strands of a fence assembled using winter fence tape. It connects the winter fence tape's shock voltage wire and the earthing wire. Connector cable length: 65cm. The shock voltage wire is marked in red.



SEE ALL HIGH TENSILE STEEL WIRE FENCE ACCESSORIES





# 7

# GATES

## GATE ASSEMBLY

When building a fence, design the gates with care from the very start. Besides the number and location of gates, optimal gate widths should be determined. Wide enough gates also allow using machinery for service and maintenance.

When designing gates for your fence, take time to consider the various use and maintenance situations possible in connection with the fence. This way, you can avoid extensive modifications in the future. Consider the following when designing gates:

### 1. Are several gates needed for the fence?

Will some of the gates be used often and others only occasionally? It is a good idea to choose more durable gate handles for gates used often and make them as user-friendly as possible in all respects: For example, perhaps it would be good to implement such a gate so that it is electrified when closed, but not when passing through it with an animal?

### 2. Are wider gates needed?

Should it be possible to drive through the fence by a tractor or even larger earthmoving machines, for example, when delivering extra sand? Is one such gate sufficient or are several needed? Where in the fence should they be located?

### 3. Are some of the gates kept open for a long time?

Gates can also be implemented so that they can be easily removed altogether, if necessary. This may be the case when providing direct access to the pasture from a winter fence. A simple way for implementing such a gate is to have gate handles at both ends.

### 4. Are passages underneath the gate required?

When you want to make sure that electricity passes through every corner of the fence even with the gate(s) open, passages should be dug underneath the gates.

A passage underneath a gate refers to electricity (in fences assembled in accordance with the winter fencing instructions, also the electricity returning to the energiser) passing from one side of the gate to the other through a high voltage cable intended for fence energiser application buried under the ground. This way, the entire fence is reliably electrified regardless of whether the gates are open or closed.

### 5. What material is used for making the gate?

You can make the gates of the materials used in the fence itself or choose an elastic, electrically conductive gate rope or metal spring gate, depending on the animals fenced and the purpose of the gate.

**Tip!** When making a multi-strand gate, use of the gate with one hand and passing through the gate with an animal is easier if the gate is assembled so that the handles can be chained to each other when opening the gate.



**Metal spring gate.** Package contents: Handle, spring, insulators. Max. spring length 4.5m. Not recommended for horses due to the risk of tail entanglement.



**Gate handle**, traditional and affordable model. Black handle, 2 pcs. per package.



**Heavy-duty gate handle** with compression string. In the heavy-duty gate handle, instead of elongation, the spring is compressed in a closed space inside the handle. Lasts clearly longer than a standard gate handle without breaking.

The **Circuit Switch for fence** can be used for switching the electricity on and off, for example, in a section of the fence or in the bottommost conductor, if the grass has grown high enough to make contact.



25m 50m 100m



The **high voltage cable** is a double-insulated special cable for conducting fence electricity underground, for example, under gates or roads, or when making longer transfers from the energiser to the fence. 3 package sizes, 25m, 50 and 100m.

For more information on gate insulators, see page 11.

2 pcs.



Gate insulator

2 pcs.



Gate insulator for fence tapes



The handles can be chained to the fence tape handle, for example.

The mounting loop of Olli's heavy-duty gate handle is also large enough for chaining the handles.

2 pcs.



# ENSURING THE FLOW OF ELECTRICITY IF THERE ARE SEVERAL GATES IN THE FENCE

If there are several gates in the fence, part of the fence may be de-energised while the gate is open. The problem can be avoided by making passages underneath the gate using **Olli High Voltage Cable**.

In case of the fence in **Figure 1**, the animal will receive a shock at any section of the fence even with the gate open; the shock (red line) is connected to the energiser from both sides of the gate. There is no need for a separate passage under the gate. **In Figure 2**, the fence section between the gates marked with blue dashed line is problematic in terms of electricity flow. In order for the animal to

receive a shock at this section also if both gates are open, the shock must be passed underneath the gate (**Figure 3**). If you build underpasses at both gates, two routes to the same point remain available for the electricity also when the gate is open.

Note that in case of a winter fence tape or two-wire fence assembled in accordance with the winter fencing instructions, the earthing wire also requires passages underneath gates.

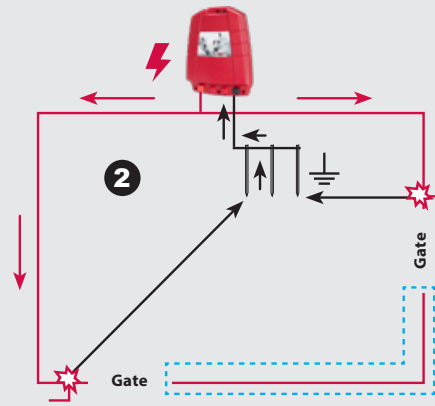
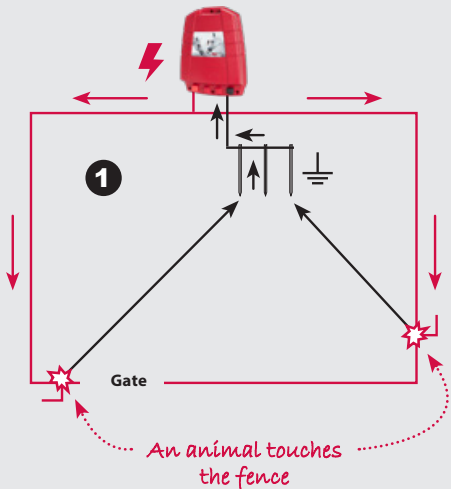

**NOTE!** Remember to bury the cables deep enough to prevent damages caused by animals trampling on them even if the soil has softened due to thawing or rainfall.

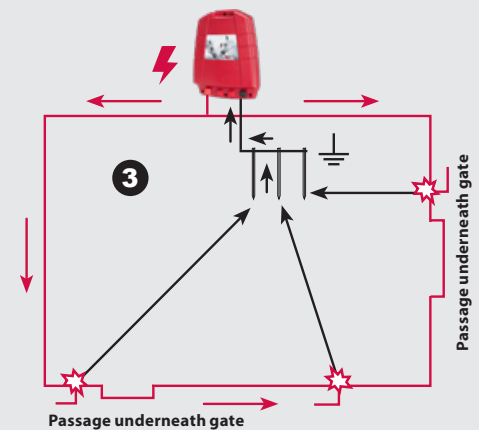

**TIP!** When making passages underneath gate, you can place the high voltage cable inside a pipe. This facilitates cable replacement, if required.

## ELASTIC ROPE GATE INSTALLATION

Attach the front end of the rope gate to the post (A) following the gate post. When the gate is closed, the rope is sufficiently taut if the handle does not hang.

If the gate is open, the handle of a correctly dimensioned rope gate is retracted to the other side of the gate and does not fall down or hang (B).

You can attach the rope gate's first end to its own, separate insulator (A), which is not connected to the actual electrified fence wire (C) at all. In such a case, the gate is energised from the handle side and is live only when closed.



Use metal rope connectors with the elastic gate rope.



The elastic gate rope is a conductive, durable, and elastic fence rope intended for gates and supplied in 25m rolls. Rope diameter 8mm. The rope sold by the metre is an excellent choice for making a gate of the exactly right size!

Electrified fence wire

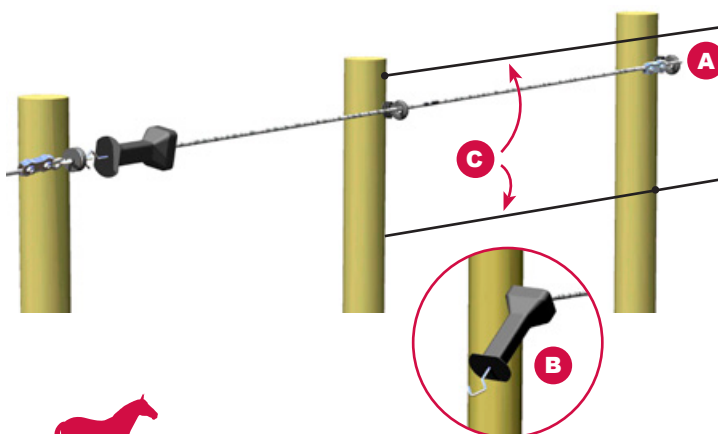

Gate rope attached to own insulator

You can build the gate so that no electricity flows through it when open. This facilitates passing through the gate, for example, in case of horses stressed because of the electric fence. If you attach the gate rope's first end to its own, separate insulator, which is not connected to the shock wire at all, the gate is supplied from the handle side and is electrified only when closed. With this configuration, a passage underneath the gate should be provided.



## NEVER THROW AN ELECTRIFIED GATE ONTO THE GROUND!

A gate energised also when open should never be thrown onto the ground, since the animal can receive an electric shock through moist ground.





# 8

# PASTURES

## BUILDING PASTURES

When building a pasture fence using plastic or fibreglass posts, place sturdy wooden posts at the fence corners for reinforcement. Light plastic or fibreglass posts bend easily if subjected to tensile force. It is also a good idea to strengthen the gates with wooden posts.

## GATHER UP ACCESSORIES INTENDED FOR SUMMER USE AT THE END OF THE SEASON

Lightweight fibreglass posts and fence conductors for summer pastures should be stored at the end of the pasture season. Storage away from the mercy of weather extends the service life of both posts and fence conductors significantly. If you want to keep the fence in place during the winter as well, choose fence posts and conductors intended for year-round use.

**Fence tape reel.** Use the reel for neat collection and storage of fence conductors on reels at the end of a season. This allows saving both time and nerves when fencing in pastures or corrals for the next time, since the process does not start with clearing up messy fence tape bundles.

**Spare reel** – you can conveniently store, for example, the conductors of different pastures on their own reels or collect fence tapes of different width on different reels.



The **horse pasture post with stirrup** greatly facilitates and speeds up fence assembly: The post can easily be pressed into the ground by stepping on the stirrup at its base! Straightening the post is easy as well.

Versatile possibilities for building different fences: All Olli fence wires, ropes and tapes of any width can be used with the posts.

Durable plastic-fibreglass mix. Suitable for year-round use, does not stick. Length 156cm, above-ground length 137cm.

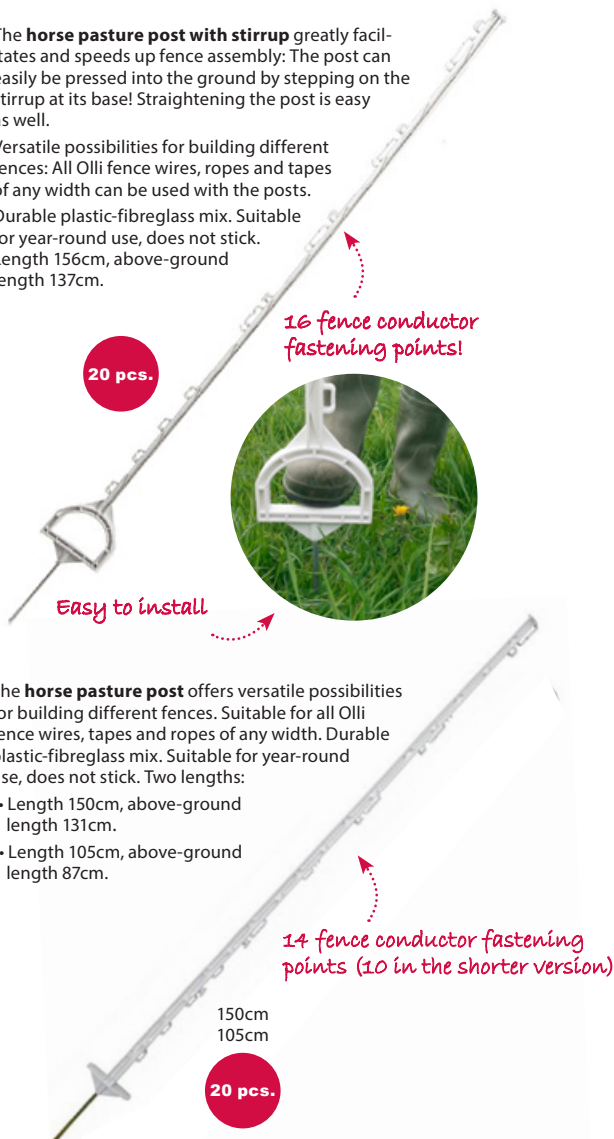

*Horse pasture posts are suitable for year-round use*



**NOTE!** Store the energiser and its battery so that contact with water is avoided at all times.



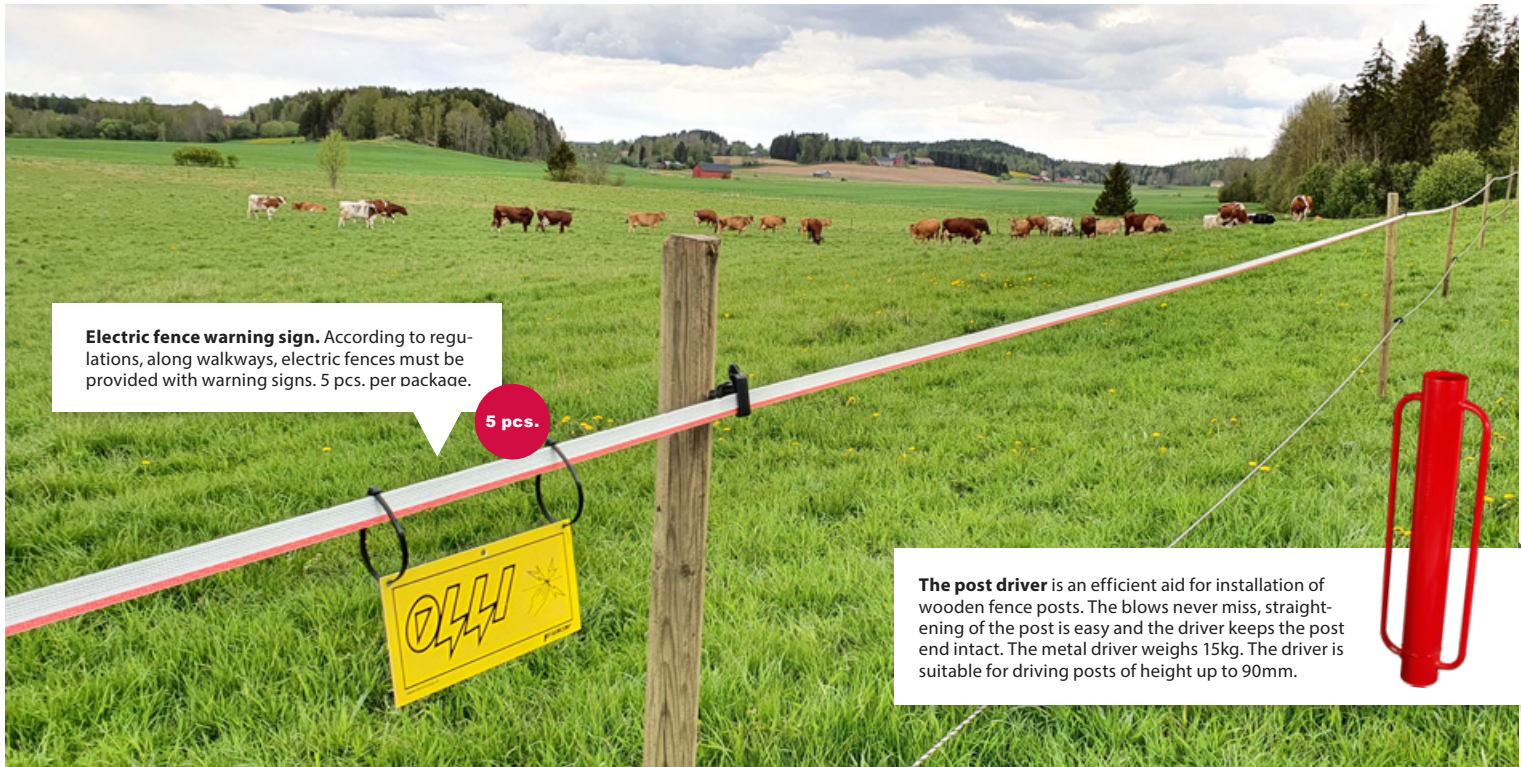

**Electric fence warning sign.** According to regulations, along walkways, electric fences must be provided with warning signs. 5 pcs. per package.

5 pcs.

**The post driver** is an efficient aid for installation of wooden fence posts. The blows never miss, straightening of the post is easy and the driver keeps the post end intact. The metal driver weighs 15kg. The driver is suitable for driving posts of height up to 90mm.



*Vegetation contacting the fence causes current leakage to the earthing, which lowers the voltage and weakens the shock.*

**REMOVE VEGETATION TOUCHING THE FENCE**

Vegetation contacting the fence causes current leakage from the fence to the earthing. The problem is aggravated if the vegetation is moist (for example, in case of fresh or dewy grass and rainy weather).

Current leaks result in voltage drop, which means weaker shock. Even a powerful energiser cannot perform its task well if there is too much vegetation leaning on the fence. Any grass, branches, etc. in contact with the fence should be removed regularly.



112cm x 50m



Electrifiable **poultry net**. Height 112cm, 50m roll. 14 pcs. steel-tipped fibreglass posts included.

100cm x 50m

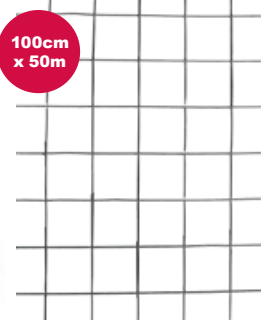

Steel **sheep net**. Height 100cm, 50m roll. Eye size 10x10cm. Hot-dip galvanized 2mm steel wire, top and bottom wire 2.5mm.

90cm x 50m



Electrifiable **sheep net**. Height 90cm, 50m roll. 14 pcs. steel-tipped fibreglass posts included.



**Spare insulator** for yellow fibreglass posts and spring steel posts. The insulators can be used with fence wires and fence tapes of maximum width 20mm.

25 pcs.



160cm  
140cm  
110cm

50 pcs.

Traditional **yellow fibreglass post** with two insulators included. The position of the lower one can be changed. Fibreglass post insulators can be used as spare insulators. The post surface structure efficiently prevents sticking. Fibreglass posts can be used with fence wires and fence tapes of maximum width 20mm. Three lengths:

- Length 160cm, above-ground length 138cm
- Length 140cm, above-ground length 108cm
- Length 110cm, above-ground length 88cm.



142cm  
108cm

25 pcs.

The **spring steel post** is a fence post made of durable spring steel with a pigtail insulator at its end. Fibreglass post insulators can be used as spare insulators. Spring steel posts can be used with fence wires, fence ropes, and fence tapes of maximum width 20mm. Two lengths::

- Length 142cm, above-ground length 124cm
- Length 108cm, above-ground length 90cm.





# 9

# SELECTION TABLES

## FENCE ENERGISERS

### MAXIMUM THEORETICAL FENCE LENGTH

ENERGISER	Maximum voltage	Voltage at 500Ω load	Stored energy	Maximum output energy	Power consumption	Ideal fence	Light vegetation	Moderate vegetation	Earthing rods
Olli Protector 11	11 700V	7 700V	14J	11J	14W	475km	65km	20km	2-5 pcs.
Olli 1000	9 500V	5 100V	9,3J	4,5J	13W	310km	30km	12km	2-5 pcs.
Olli 950	10 000V	5 000V	8,9J	4,8J	11W	310km	30km	12km	2-5 pcs.
Olli 600	9 200V	3 900V	6J	3,8J	7W	220km	25km	10km	1-3 pcs.
Olli 300	9 000V	3 700V	3,8J	2,8J	4W	160km	20km	7km	1-2 pcs.
Olli 100	6 500V	3 400V	1,4J	1,2J	2W	60km	12km	3km	1 pc.
Olli 450B+ 	8 000V	4 650V	4,6J	3,0J	160-310mA	190km	23km	8km	1-3 pcs.
Olli 250B+ 	7 400V	5 000V	2,6J	2,0J	70-200mA	90km	18km	6km	1-2 pcs.
Olli 180B	9 500V	3 200V	1,7J	1,4J	130mA	80km	15km	4km	1-2 pcs.
Olli 122B 	8 500V	3 880V	1,63J	1,21J	46-109mA	62km	12km	3km	1-2 pcs.
Olli 9.07B 	9 800V	3 200V	0,86J	0,71J	40-85 / 30-62 mA <sup>a)</sup>	35km	7km	2km	1-2 pcs.
Olli 9.07S 	9 800V	3 200V	0,86J	0,71J	40-85 / 30-62mA <sup>a)</sup>	35km	7km	2km	1-2 pcs.
Olli SG3 Batteries 12 V battery	4 800V 6 800V	2 040V 3 100V	0,18J 0,5J	0,125J 0,3J	17-33mA 18-40mA	9km 20km	1km 3km	0,3km 1km	1 pc.

<sup>a)</sup>Olli 9.07B and 9.07S power consumption (9V battery/12V battery)  Solar panel or solar panel option as an accessory.

## HOW TO INTERPRET TECHNICAL SPECIFICATIONS

Maximum voltage, U <sub>max</sub>	Volt (V)	Indicates the peak impulse voltage in case of a short, leak-free fence (low load) or without a fence. Because energiser voltages are quite high, the values are often expressed in kilovolts (kV), i.e., in thousands of volts.
Voltage at 500 Ohm load (U <sub>500 Ω</sub> )	Volt (V)	Indicates the peak impulse voltage if the fence is heavily loaded.
Stored energy (E <sub>charged</sub> )	Joule (J)	The maximum energy that the energiser can build up for a shock.
Maximum output energy (E <sub>out</sub> )	Joule (J)	Indicates the shock intensity, in other words, the maximum energy the fence energiser is capable of supplying to the fence in a single impulse. The higher the energy, the longer the fence serviceable by the energiser. A high-energy shock is also more perceptible, since it lasts longer. When comparing energisers, this is a value worth paying attention to.
Power consumption (watts, milliamperes)	W, mA	Indicates the maximum actual electricity consumption. In case of a mains energiser, 10W power in round-the-clock use means an annual consumption of 87.6kWh. At a price of €0.15/kWh, using the energiser would cost about €13 a year. A battery energiser is powered from a battery. In many models, power consumption varies depending on the energiser's power setting and/or fence load. The maximum battery life (in hours, h) can be estimated by dividing the declared capacity of the battery (e.g., 60Ah = 60,000mAh) by the energiser's declared power consumption: 60,000mAh/100mA = 600h = 25 days.
Recommended number of earthing rods	pcs.	Recommended quantity for the energiser in question. Instead of a single figure, it is indicated as a range, for example, 1-3 pcs., since in dry soil, more earthing rods are required as compared to moist soil. The same applies in case of a more powerful energiser and longer fence.
Maximum theoretical fence length	km	The longest theoretical single-wire fence built of thick metal wire in which the fence voltage can still be sufficient for fence functionality. Indicated in kilometres. In practice, such a situation is truly rare, almost impossible. Nevertheless, alike maximum output energy, the value is useful, for example, when comparing energiser models from different manufacturers.
Maximum theoretical fence length (light vegetation)	km	A value more suitable for comparison when assessing the suitability of an energiser for your fence. Refers to a situation where the fence consists of conductors that conduct electricity well and there is little vegetation in contact with the fence. Note that this value indicates the total length of the fence, i.e., with all of the fence conductor strands combined.
Maximum theoretical fence length (moderate vegetation)	km	Refers to a situation where there is more vegetation in contact with the fence. Note that this value indicates the total length of the fence, i.e., with all of the fence conductor strands combined.



The lower the resistance ( $\Omega/m$ ) of a fence conductor, the better it conducts electricity.

## FENCE CONDUCTORS



	Roll	Resistance	Tensile strength
Fencing wire 1,4mm	400m	0,091 $\Omega/m$	85kg
Steel fence wire 2,0mm	1025m	0,060 $\Omega/m$	270kg
Steel fence wire 2,5mm	650m	0,036 $\Omega/m$	400kg
Olli fence wire 3mm	200m / 1000m	0,98 $\Omega/m$	80kg
Olli fence rope 5mm	300m	1,6 $\Omega/m$	198kg
Olli fence rope 8mm	200m	1,6 $\Omega/m$	398kg
Olli green fence tape 12mm	200m	0,86 $\Omega/m$	86kg
Olli green fence tape 20mm	200m	0,8 $\Omega/m$	162kg
Olli green fence tape 40mm	200m	0,48 $\Omega/m$	258kg
Olli red-and-white fence tape 12mm	200m	0,58 $\Omega/m$	62kg
Olli red-and-white fence tape 20mm	200m	0,91 $\Omega/m$	121kg
Olli red-and-white fence tape 40mm	200m	0,73 $\Omega/m$	195kg
Olli winter fence tape 40mm	200m	0,6 $\Omega/m$	221kg

### Olli Digitester+

Olli Digitester+ is a fence voltage tester equipped with digital display that shows the fence voltage (kV) clearly in numbers. 9V battery included.



### Olli Supertester+

A fence voltage tester with six-stage light display. Fence voltage display 2,000-12,000V. The tester does not require a separate battery. It draws power supply directly from the fence tested.

With fence voltage testers, you can test the energiser's functionality and measure the fence voltage.

For instructions on how to test your energiser and fence, see the Determination of electric fence condition blog:

## HELP, THE FENCE DOES NOT WORK!

If there is a problem with the fence, you should first carry out the traditional sensory checks:

1. Is the energiser's power on? Does it seem to function?
2. Does the fence look intact?
3. Are the gates closed?
4. Is it summer and the soil terribly dry?
5. Has the grass grown tall enough to reach the fence?
6. Is it winter and the ground covered in snow and ice?

After this, examine the fence systematically:

1. First, test if the energiser works (without fence)
2. Check the connector wire between the fence and the energiser
3. Check earthing
4. Check the fence itself: Fence conductors, connections and insulators

Read comprehensive instructions on Olli's blog!



## DETERMINATION OF ELECTRIC FENCE CONDITION

The fence does not work. There is no electricity in the fence. There is no shock from the fence. The shock is weak. The electric fence does not work in winter. Sounds familiar? Determination of electric fence condition requires a systematic approach. This way, you can find out where the problem lies: In the energiser or in the fence – or perhaps between them.

### READ INSTRUCTIONS ON OLLI'S BLOG

Comprehensive instructions on how to determine the condition of an electric fence are available on Olli's blog: [olli.fi/determination-of-electric-fence-condition](https://olli.fi/determination-of-electric-fence-condition)

Determination of electric fence condition ►





The logo for OLLI, featuring the word "OLLI" in a bold, red, italicized sans-serif font with a lightning bolt shape integrated into the letter "L".

**OLLI**

A white silhouette of a cow on the left and a white silhouette of a horse on the right, positioned above the main title text.

# FENCING

# GUIDE 2022

A small white silhouette of a cow, positioned below the word "GUIDE" in the title.