

Engine 4TNV98CT
Engine power 53,7 kW - 73,0 HP
Operating Weight 4.350 kg

ESK 190 T₄

Concrete solutions. Always



TECHNICALS SPECIFICATIONS

Operating weight	kg	4.350
ENGINE		
Type	YANMAR 4TNV98CT EU Stage IIIB EPA Tier 4	
Max Power (2.600 rpm)	kW - HP	53,7 - 73,0
Max torque	Nm	291 (1.625 rpm)
Displacement	cc	3.319
Number of cylinders	n°	4
Cooling	water	
Consumption	lt/h	11
Alternator	V (A)	12 (80)
Battery	V (Ah)	12 (100/850)
HYDRAULIC SYSTEM		
Pump type	N° 1 with variable displacement axial piston pumps with load sensing REXROTH	
Pump capacity	lt/min	160
Max. circuit calibration pressure	bar	280
High Flow System (standard): Max capacity Max pressure	lt/min bar	160 280
TRANSMISSION		
Type	Hydrostatic with electro-hydraulic tandem pump and radial pistons REXROTH gearboxes	
Travelling speed	km/h	1 ^a : 0 ÷ 9,0 / 2 ^a : 0 ÷ 18,0
Max Traction force	daN	4.450
Dimensions tires	12x16.5	
BRAKES		
Service brakes	Hydrostatic	
Parking brakes	Negative with multiple disks into oil bath, integrated on the gearboxes at electrohydraulic control	
Emergency brakes	Electrohydraulic control, acting on parking brakes (integrated on the gearboxes)	
PERFORMANCES		
Upsetting load (ISO 14397)	kg	2.920
Operating load (ISO 14397, no more than 50% of tipping load)	kg	1.450
Teeth breakout force	daN	3.985
Standard bucket capacity	m ³	0,56
Standard bucket width	mm	1.860
Max slope	60% - 30°	
FILLINGS		
Fuel tank	lt	110
Hydraulic oil tank	lt	55
Hydraulic circuit capacity	lt	93
Cooling system capacity	lt	12
Engine oil	lt	6
CONTROLS		
Type	Ergonomic joystick with electronic controls and onboard safety lock	
Translation	Electro-hydraulic control on left hand joystick	
Services	Electric control with right hand joystick for lifting and bucket	
Lifting mechanism	Vertical lifting boom with a standard self-levelling system for the bucket (only for boom rising)	

ESK 190 T₄

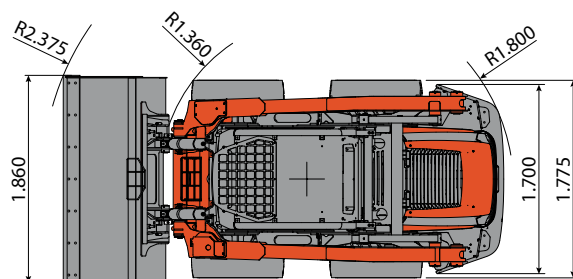
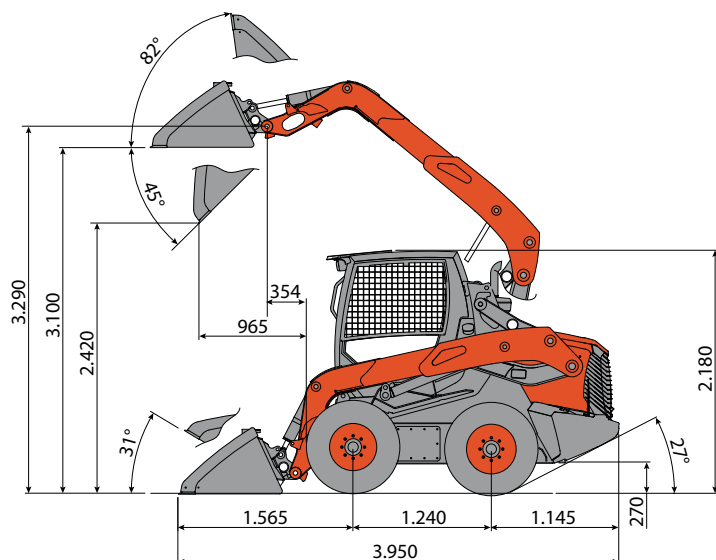

- Homologation for road traffic (only Italy).
- The ROPS (ISO 3471) – FOPS (ISO 3449) engineer standards manufactured cab or canopy.
- Front and rear lights for night-road use and working.

 **EUROCOMACH**

Sampierana S.p.A.

47021 S.Piero in Bagno (FC)
via Leonardo da Vinci, 40
Tel +39 0543.904211
Fax +39 0543.918520
www.eurocomach.com